



Nu-Guard® 31 Steel Guardrail System

A smaller footprint, lighter weight and no requirement for a blockout means the Nu-Guard® 31 steel post guardrail system is comparable in cost to wooden post systems and is simpler and quicker to install.



Features

- » System has a smaller footprint and no blockout
- » NUCOR™ steel posts, with no blockout, enables faster installation
- » NUCOR™ steel posts are one third the weight and 16 times smaller in area than timber posts
- » High tensile galvanised NUCOR™ steel post is designed for easy after-impact repair of system
- » Environmentally friendly - manufactured using recycled steel
- » Uses standard highway rail and fixings
- » A median or roadside barrier
- » NUCOR™ steel posts will split on impact to avoid guardrail tearing, reducing the incidence of wheel snagging
- » It is possible for one post to be installed per minute using a post rammer

Specifications

- » Tested and approved to MASH TL-3 and NCHRP 350 TL-4
- » Post weight: 14.78 kg
- » Post length: 1980mm
- » Height: 0.78m
- » Height to centre of rail: 635mm
- » Post footprint: 0.0375m²
- » System deflection is a maximum of 1200mm for median and roadside applications
- » Maximum 1.30m deflection at **MASH TL-3** criteria
- » No blockouts required
- » Standard highway rail and fixings
- » All components hot dip galvanised
- » Post - High tensile steel

More information on Nu-Guard® 31 can be found at www.csppacific.co.nz or call **0800 655 200**

Leading road side and barrier systems supplier

CSP PACIFIC

306 Neilson St, Onehunga,
PO Box 12 949, Penrose,
Auckland 1642, New Zealand
www.csppacific.co.nz

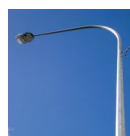

Columns



Multiplate



Hire



Barriers



Traffic Control



Nu-Guard® 31 Steel Guardrail System

Nu-Guard® 31 system assembly

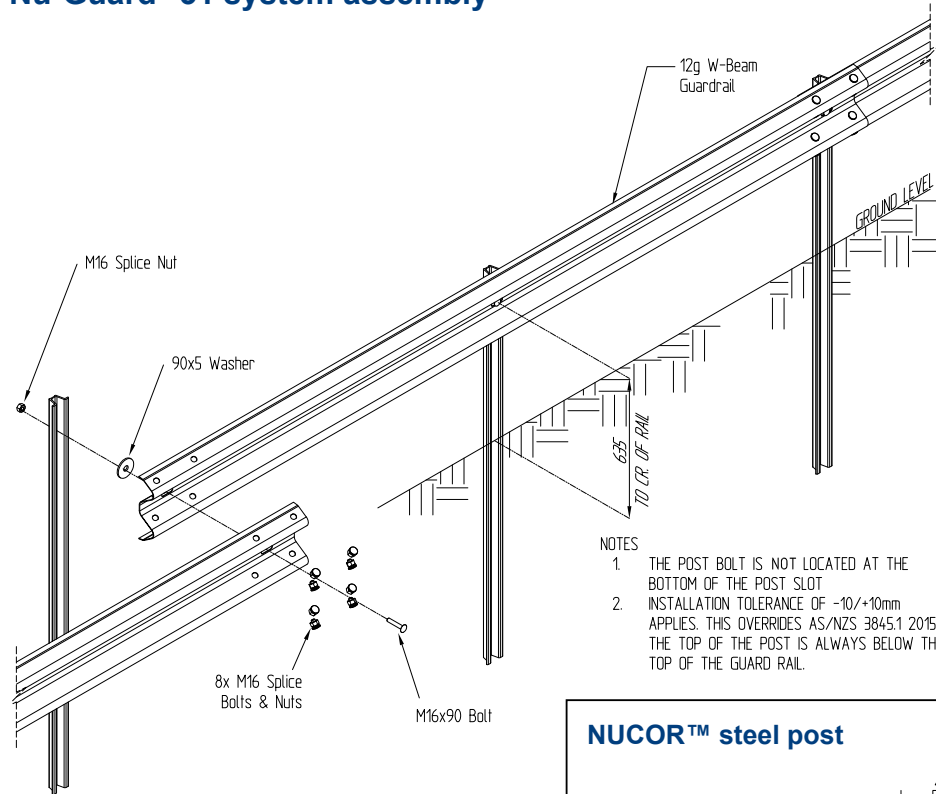

- NOTES
1. THE POST BOLT IS NOT LOCATED AT THE BOTTOM OF THE POST SLOT
 2. INSTALLATION TOLERANCE OF ± 10 mm APPLIES. THIS OVERRIDES AS/NZS 3845.1 2015. THE TOP OF THE POST IS ALWAYS BELOW THE TOP OF THE GUARD RAIL.

NUCOR™ steel post

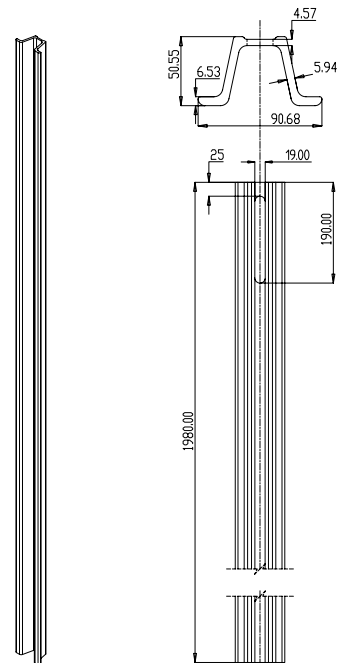
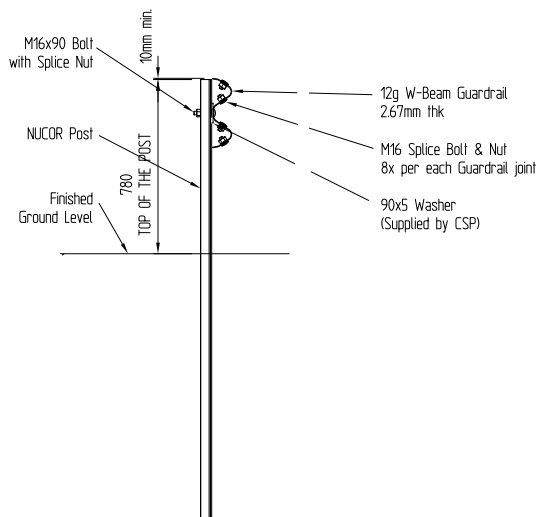

More information on **Nu-Guard® 31** can be found at www.cspacific.co.nz or call **0800 655 200**

CSP Pacific | Nu-Guard® 31 Steel Guardrail System Brochure | September 2018

Leading road side and barrier systems supplier

CSP PACIFIC

306 Neilson St, Onehunga,
PO Box 12 949, Penrose,
Auckland 1642, New Zealand
www.cspacific.co.nz

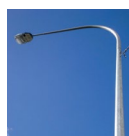

Columns



Multiplate



Hire



Barriers



Traffic Control



Nu-Guard® 31 Steel Guardrail System

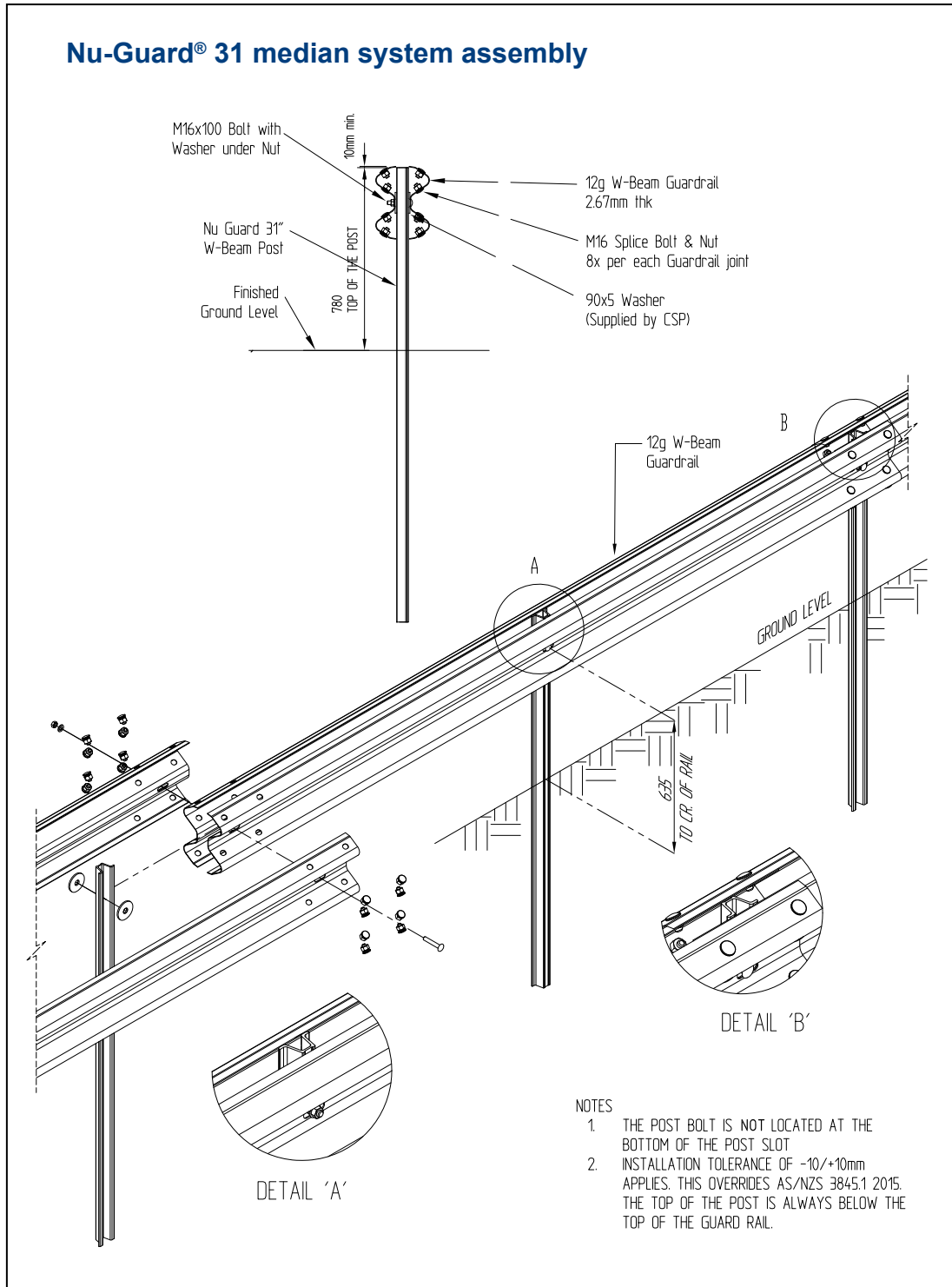

More information on **Nu-Guard® 31** can be found at www.cspacific.co.nz or call **0800 655 200**

Leading road side and barrier systems supplier

CSP PACIFIC

306 Neilson St, Onehunga,
 PO Box 12 949, Penrose,
 Auckland 1642, New Zealand
www.cspacific.co.nz

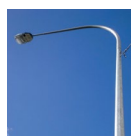

Columns



Multiplate



Hire



Barriers



Traffic Control